

**SIEMENS**

T-41-83

**CNY17F SERIES**  
**VDE LEAD BEND CNY17G F SERIES**  
**SINGLE CHANNEL**  
**PHOTOTRANSISTOR OPTOCOUPLER**  
**NO BASE CONNECTION**

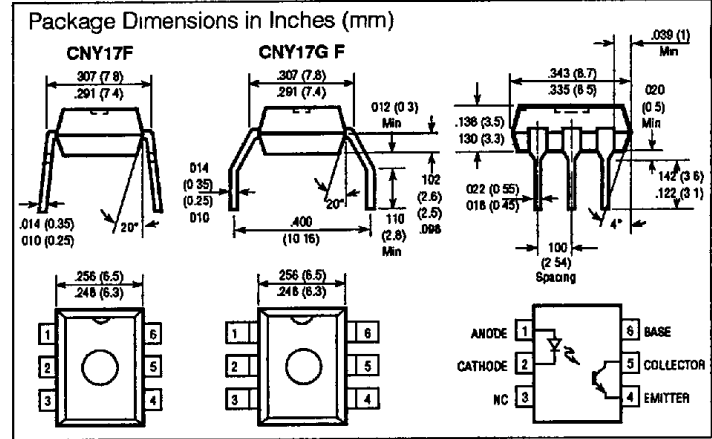
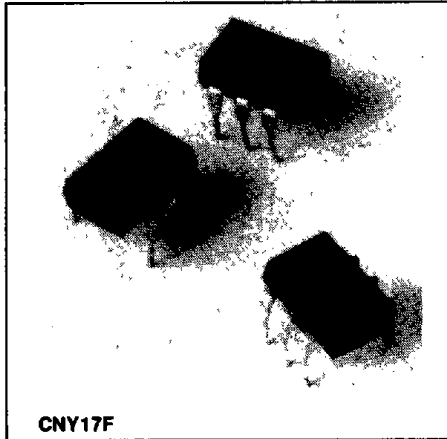

**FEATURES**

- **CNY17F G Lead Bend in Accordance with VDE 0805/0806**
- **5300 Volt Breakdown Voltage**
- **Base Terminal not connected for improved Common Mode Interface Immunity**
- **High Current Transfer Ratio, 4 Groups**  
 CNY17F/G F-1, 40 to 80%  
 CNY17F/G F-2, 63 to 125%  
 CNY17F/G F-3, 100 to 200%  
 CNY17F/G F-4, 160 to 320%
- **Low CTR Degradation**
- **High Collector-emitter Voltage  $V_{CE0} = 70V$**
- **100% Burn-in**
- **VDE Approval #0883**
- **VDE Approval #0884 (Optional with Option 1, add -X001 suffix)**
- **Conforms to VDE #0805/0806**

**DESCRIPTION**

The CNY17F/G F is an optocoupler that employs a GaAs infrared emitting diode optically coupled to a silicon planar phototransistor detector. The component is incorporated in a plastic plug-in DIP-6 package. The coupling device is suitable for signal transmission between two electrically separated circuits. The potential difference between the circuits to be coupled is not allowed to exceed the maximum permissible reference voltages.

In contrast to the CNY17 Series, the base terminal of the F/G F type is not connected. This results in a substantially improved common-mode interference immunity.

**Maximum Ratings:**

<b>Emitter (GaAs infrared emitter)</b>		
Reverse voltage	$V_R$ 6	V
DC forward current	$I_f$ 60	mA
Surge forward current ( $t \leq 10 \mu s$ )	$I_{FSM}$ 2.5	A
Total power dissipation	$P_{tot}$ 100	mW
<b>Detector (silicon phototransistor)</b>		
Collector-emitter reverse voltage	$V_{CE0}$ 70	V
Collector current	$I_C$ 50	mA
Collector current ( $t \leq 1 ms$ )	$I_{CSM}$ 100	mA
Total power dissipation	$P_{tot}$ 150	mW
<b>Optocoupler</b>		
Storage temperature range	$T_{stg}$ -40 + 150	°C
Ambient temperature range	$T_{amb}$ -40 + 100	°C
Junction temperature	$T_j$ 100	°C
Soldering temperature (max 10s) <sup>1)</sup>	$T_s$ 260	°C
Isolation test voltage <sup>2)</sup>	$V_{IO}$ 5300	Vdc
Leakage path	> 8.0	mm
Air Path		
CNY17F	> 7.3	mm
CNY17G F	> 8.0	mm
<b>Tracking resistance</b>		
in acc. with VDE 0110 § 6, table 3 and DIN 53480/VDE 0303, part 1	KB	$\geq 100$ (group 3)
Isolation resistance ( $V_{IO} = 500 V$ )	$R_{IO}$	$10^{11}$ $\Omega$

**Characteristics ( $T_{amb} = 25^\circ C$ )**

<b>Emitter (GaAs infrared emitter)</b>		
Forward voltage ( $I_f = 60 mA$ )	$V_f$ 1.25 ( $\leq 1.65$ )	V
Breakdown voltage ( $I_R = 10 \mu A$ )	$BV$ 30 ( $\geq 6$ )	V
Reverse current ( $V_R = 6 V$ )	$I_R$ 0.01 ( $\leq 10$ )	$\mu A$
Capacitance ( $V_R = 0 V, f = 1 MHz$ )	$C_0$ 4.0	pF
Thermal resistance <sup>1)</sup>	$R_{thJA}$ 750	K/W
<b>Detector (silicon phototransistor)</b>		
Capacitance ( $V_{CE} = 5 V, f = 1 MHz$ )	$C_{ct}$ 6.8	pF
Thermal resistance <sup>1)</sup>	$R_{thJA}$ 500	K/W
<b>Optocoupler</b>		
Collector-emitter saturation voltage ( $I_f = 10 mA, I_C = 2.5 mA$ )	$V_{CEsat}$ 0.25 ( $\leq 0.4$ )	V
Coupling capacitance	$C_c$ 0.5	pF

T-4-83

The optocouplers are grouped according to their current transfer ratio  $I_C/I_F$  at  $V_{CE}=5V$ , marked by dash numbers

	-1	-2	-3	-4	
$I_C/I_F$ ( $I_F=10\text{ mA}$ )	40-80	63-125	100-200	160-320	%
$I_C/I_F$ ( $I_F=1\text{ mA}$ )	30 (>13)	45 (>22)	70 (>34)	90 (>56)	%
Collector-Emitter Leakage Current ( $V_{CE}=10\text{ V}$ ) ( $I_{CEO}$ )	2 ( $\leq 50$ )	2 ( $\leq 50$ )	5 ( $\leq 100$ )	5 ( $\leq 100$ )	nA

**Linear Operation (without saturation)**

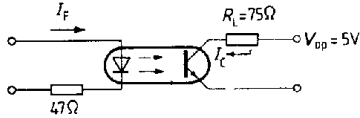

$I_F=10\text{ mA}$ ,  $V_{OP}=5\text{ V}$ ,  $T_{amb}=25^\circ\text{C}$

Load Resistance	$R_L$	75	$\Omega$
Turn-On Time	$t_{ON}$	3.0 ( $\leq 5.6$ )	$\mu\text{s}$
Rise Time	$t_r$	2.0 ( $\leq 4.0$ )	$\mu\text{s}$
Turn-Off Time	$t_{OFF}$	2.3 ( $\leq 4.1$ )	$\mu\text{s}$
Fall Time	$t_f$	2.0 ( $\leq 3.5$ )	$\mu\text{s}$
Cut-Off Frequency	$F_{\infty}$	250	kHz

**Switching Operation (with saturation)**

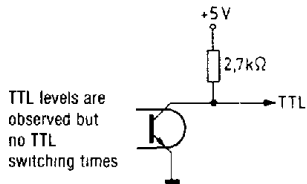
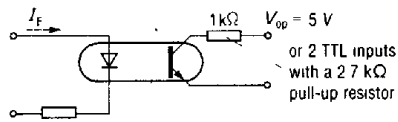

Group	-1 ( $I_F=20\text{ mA}$ )	-2 and -3 ( $I_F=10\text{ mA}$ )	-4 ( $I_F=5\text{ mA}$ )	
Turn-On Time $t_{ON}$	3.0 ( $\leq 5.5$ )	4.2 ( $\leq 8.0$ )	6.0 ( $\leq 10.5$ )	$\mu\text{s}$
Rise Time $t_r$	2.0 ( $\leq 4.0$ )	3.0 ( $\leq 6.0$ )	4.6 ( $\leq 8.0$ )	$\mu\text{s}$
Turn-Off Time $t_{OFF}$	18 ( $\leq 34$ )	23 ( $\leq 39$ )	25 ( $\leq 43$ )	$\mu\text{s}$
Fall Time $t_f$	11 ( $\leq 20$ )	14 ( $\leq 24$ )	15 ( $\leq 26$ )	$\mu\text{s}$
$V_{CEBAT}$		0.25 ( $\leq 0.4$ )		V

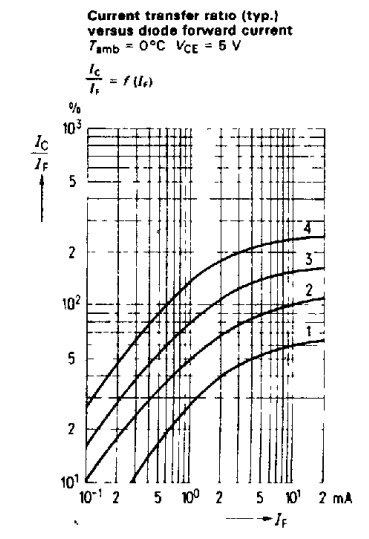
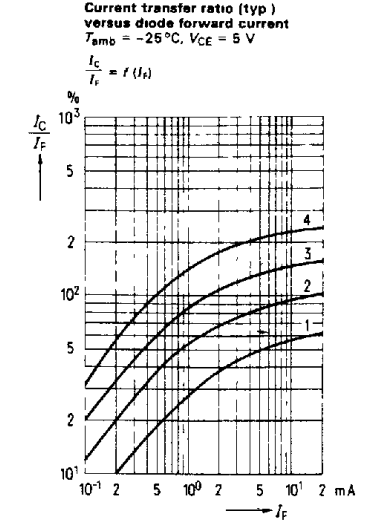
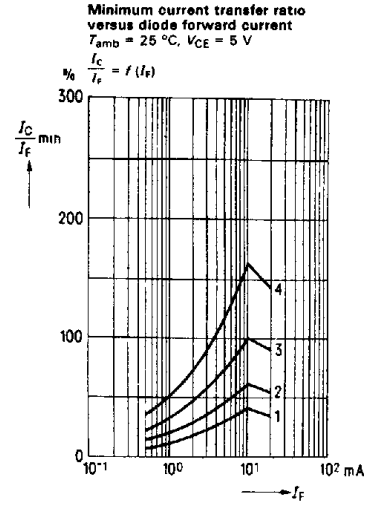

Optocouplers (Optoisolators)

T-4183

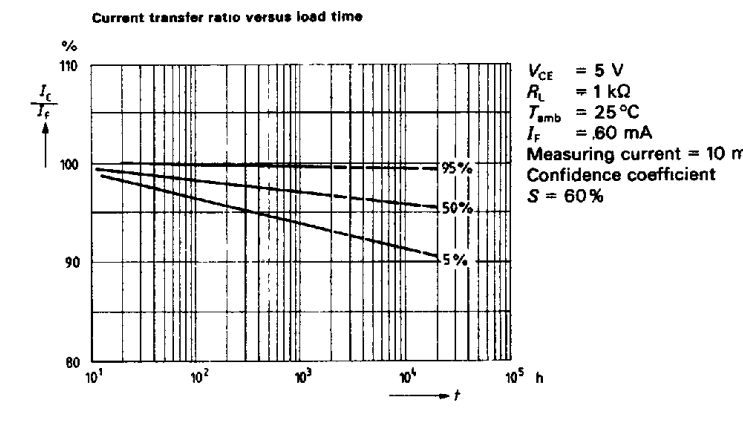
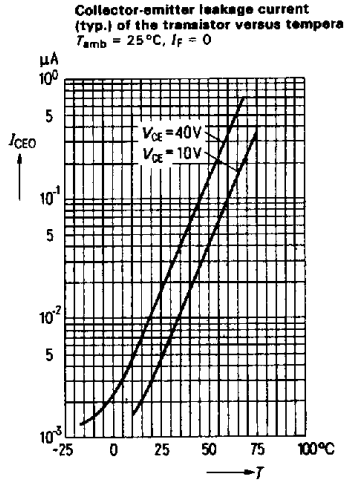
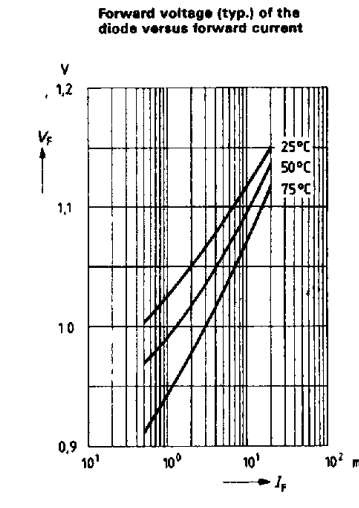
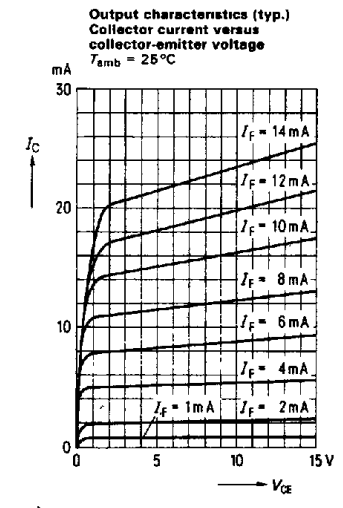
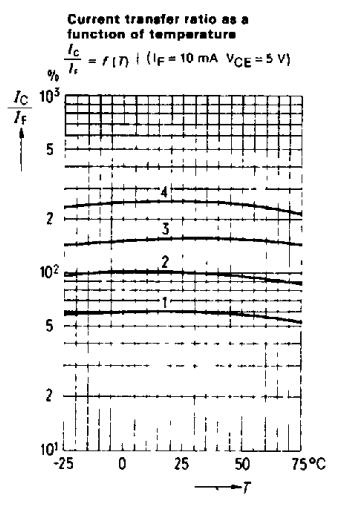
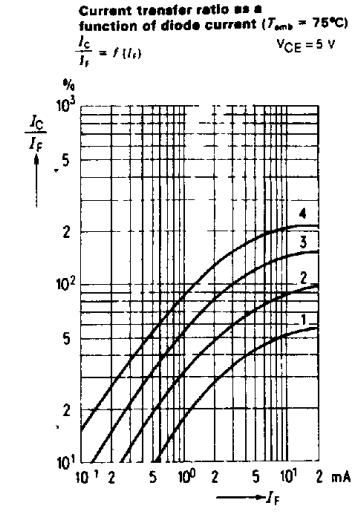
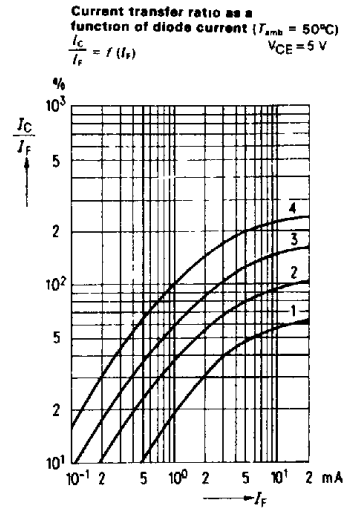
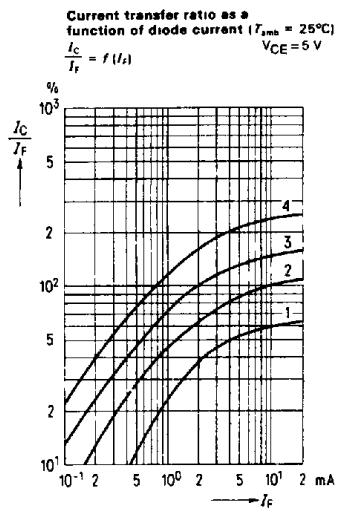

T-4183

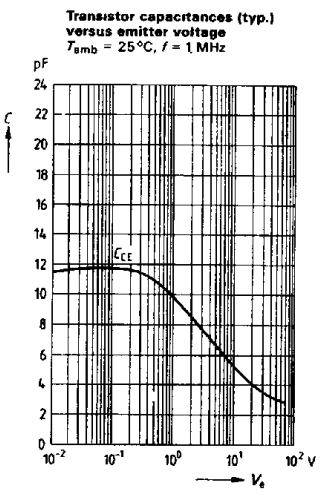
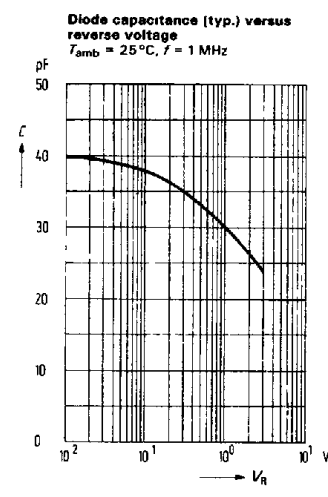
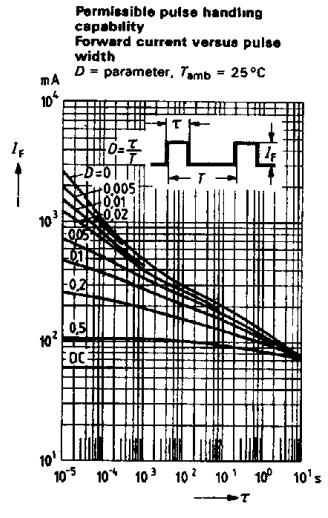
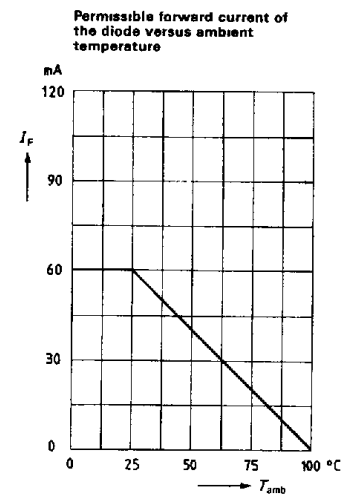
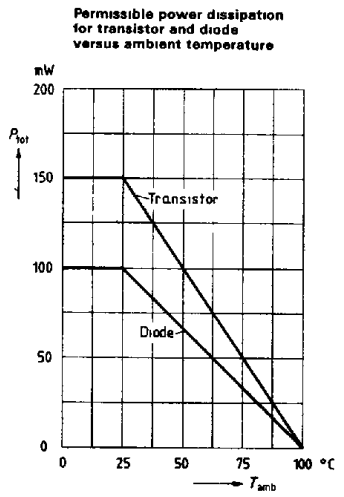
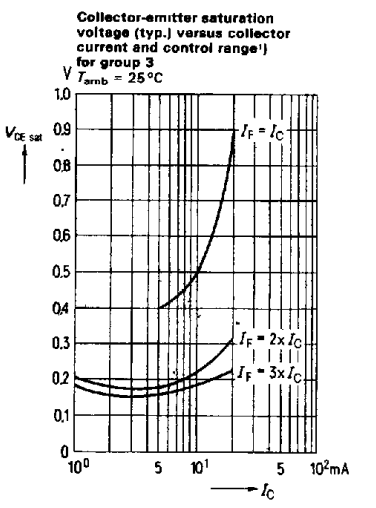
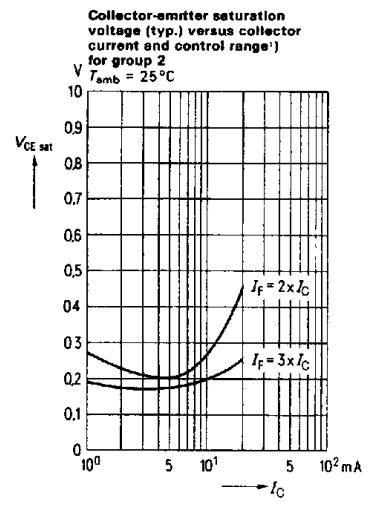
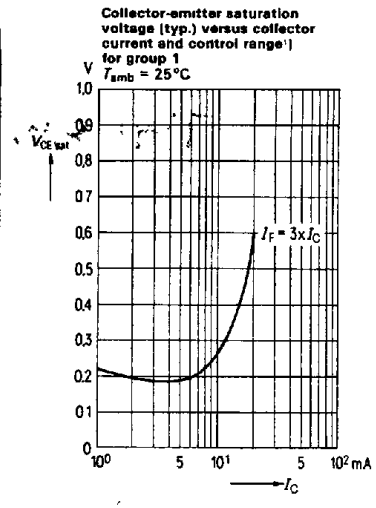

Optocouplers (Optoisolators)