

CD4046BM/CD4046BC Micropower Phase-Locked Loop

General Description

The CD4046B micropower phase-locked loop (PLL) consists of a low power, linear, voltage-controlled oscillator (VCO), a source follower, a zener diode, and two phase comparators. The two phase comparators have a common signal input and a common comparator input. The signal input can be directly coupled for a large voltage signal, or capacitively coupled to the self-biasing amplifier at the signal input for a small voltage signal.

Phase comparator I, an exclusive OR gate, provides a digital error signal (phase comp. I Out) and maintains 90° phase shifts at the VCO center frequency. Between signal input and comparator input (both at 50% duty cycle), it may lock onto the signal input frequencies that are close to harmonics of the VCO center frequency.

Phase comparator II is an edge-controlled digital memory network. It provides a digital error signal (phase comp. II Out) and lock-in signal (phase pulses) to indicate a locked condition and maintains a 0° phase shift between signal input and comparator input.

The linear voltage-controlled oscillator (VCO) produces an output signal (VCO Out) whose frequency is determined by the voltage at the VCO_{IN} input, and the capacitor and resistors connected to pin C1_A, C1_B, R1 and R2.

The source follower output of the VCO_{IN} (demodulator Out) is used with an external resistor of 10 kΩ or more.

The INHIBIT input, when high, disables the VCO and source follower to minimize standby power consumption. The zener diode is provided for power supply regulation, if necessary.

Features

- Wide supply voltage range 3.0V to 18V
- Low dynamic power consumption 70 μW (typ.) at $f_o = 10 \text{ kHz}$, $V_{DD} = 5V$
- VCO frequency 1.3 MHz (typ.) at $V_{DD} = 10V$
- Low frequency drift with temperature 0.06%/°C at $V_{DD} = 10V$
- High VCO linearity 1% (typ.)

Applications

- FM demodulator and modulator
- Frequency synthesis and multiplication
- Frequency discrimination
- Data synchronization and conditioning
- Voltage-to-frequency conversion
- Tone decoding
- FSK modulation
- Motor speed control

Block & Connection Diagrams

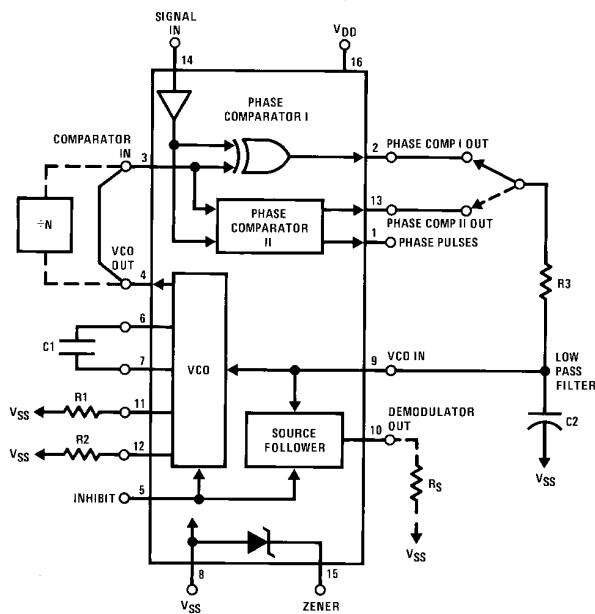
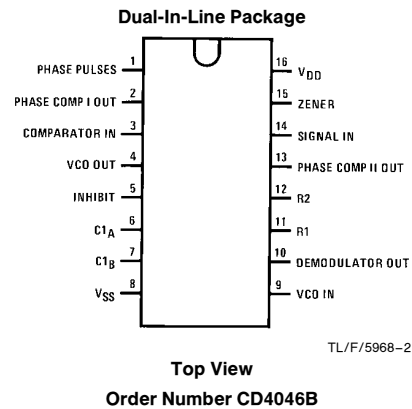

FIGURE 1

TL/F/5968-1



TL/F/5968-2

CD4046BM/CD4046BC Micropower Phase-Locked Loop

Absolute Maximum Ratings (Notes 1 & 2)

If Military/Aerospace specified devices are required, please contact the National Semiconductor Sales Office/Distributors for availability and specifications.

DC Supply Voltage (V_{DD})	-0.5 to +18 V_{DC}
Input Voltage (V_{IN})	-0.5 to V_{DD} + 0.5 V_{DC}
Storage Temperature Range (T_S)	-65°C to +150°C
Power Dissipation (P_D)	
Dual-In-Line	700 mW
Small Outline	500 mW
Lead Temperature (T_L)	
(Soldering, 10 seconds)	260°C

Recommended Operating Conditions (Note 2)

DC Supply Voltage (V_{DD})	3 to 15 V_{DC}
Input Voltage (V_{IN})	0 to V_{DD} V_{DC}
Operating Temperature Range (T_A)	
CD4046BM	-55°C to +125°C
CD4046BC	-40°C to +85°C

DC Electrical Characteristics CD4046BM (Note 2)

Symbol	Parameter	Conditions	-55°C		+25°C			+125°C		Units
			Min	Max	Min	Typ	Max	Min	Max	
I_{DD}	Quiescent Device Current	Pin 5 = V_{DD} , Pin 14 = V_{DD} , Pin 3, 9 = V_{SS} V_{DD} = 5V V_{DD} = 10V V_{DD} = 15V		5	0.005	5		150	μA	
				10	0.01	10		300	μA	
				20	0.015	20		600	μA	
		Pin 5 = V_{DD} , Pin 14 = Open, Pin 3, 2 = V_{SS} V_{DD} = 5V V_{DD} = 10V V_{DD} = 15V		45	5	35		185	μA	
	450		20	350		650	μA			
	1200		50	900		1500	μA			
V_{OL}	Low Level Output Voltage	V_{DD} = 5V		0.05	0	0.05		0.05	V	
		V_{DD} = 10V		0.05	0	0.05		0.05	V	
		V_{DD} = 15V		0.05	0	0.05		0.05	V	
V_{OH}	High Level Output Voltage	V_{DD} = 5V	4.95		4.95	5		4.95	V	
		V_{DD} = 10V	9.95		9.95	10		9.95	V	
		V_{DD} = 15V	14.95		14.95	15		14.95	V	
V_{IL}	Low Level Input Voltage Comparator and Signal In	V_{DD} = 5V, V_O = 0.5V or 4.5V		1.5	2.25	1.5		1.5	V	
		V_{DD} = 10V, V_O = 1V or 9V		3.0	4.5	3.0		3.0	V	
		V_{DD} = 15V, V_O = 1.5V or 13.5V		4.0	6.25	4.0		4.0	V	
V_{IH}	High Level Input Voltage Comparator and Signal In	V_{DD} = 5V, V_O = 0.5V or 4.5V	3.5		3.5	2.75		3.5	V	
		V_{DD} = 10V, V_O = 1V or 9V	7.0		7.0	5.5		7.0	V	
		V_{DD} = 15V, V_O = 1.5V or 13.5V	11.0		11.0	8.25		11.0	V	
I_{OL}	Low Level Output Current (Note 4)	V_{DD} = 5V, V_O = 0.4V	0.64		0.51	0.88		0.36	mA	
		V_{DD} = 10V, V_O = 0.5V	1.6		1.3	2.25		0.9	mA	
		V_{DD} = 15V, V_O = 1.5V	4.2		3.4	8.8		2.4	mA	
I_{OH}	High Level Output Current (Note 4)	V_{DD} = 5V, V_O = 4.6V	-0.64		-0.51	-0.88		-0.36	mA	
		V_{DD} = 10V, V_O = 9.5V	-1.6		-1.3	-2.25		-0.9	mA	
		V_{DD} = 15V, V_O = 13.5V	-4.2		-3.4	-8.8		-2.4	mA	
I_{IN}	Input Current	All Inputs Except Signal Input V_{DD} = 14V, V_{IN} = 0V V_{DD} = 15V, V_{IN} = 15V		-0.1		-10 ⁻⁵	-0.1		μA	
				0.1		10 ⁻⁵	0.1		1.0	μA
C_{IN}	Input Capacitance	Any Input (Note 3)						7.5	pF	
P_T	Total Power Dissipation	f_o = 10 kHz, R_1 = 1 M Ω R_2 = ∞ , $V_{CO_{IN}}$ = $V_{DD}/2$ V_{DD} = 5V V_{DD} = 10V V_{DD} = 15V				0.07			mW	
						0.6			mW	
						2.4			mW	

DC Electrical Characteristics CD4046BC (Note 2)

Symbol	Parameter	Conditions	-40°C		+25°C			+85°C		Units
			Min	Max	Min	Typ	Max	Min	Max	
I _{DD}	Quiescent Device Current	Pin 5 = V _{DD} , Pin 14 = V _{DD} , Pin 3, 9 = V _{SS} V _{DD} = 5V		20		0.005	20		150	μA
		V _{DD} = 10V		40		0.01	40		300	μA
		V _{DD} = 15V		80		0.015	80		600	μA
		Pin 5 = V _{DD} , Pin 14 = Open, Pin 3, 9 = V _{SS} V _{DD} = 5V		70		5	55		205	μA
		V _{DD} = 10V		530		20	410		710	μA
		V _{DD} = 15V		1500		50	1200		1800	μA
V _{OL}	Low Level Output Voltage	V _{DD} = 5V		0.05		0	0.05		0.05	V
		V _{DD} = 10V		0.05		0	0.05		0.05	V
		V _{DD} = 15V		0.05		0	0.05		0.05	V
V _{OH}	High Level Output Voltage	V _{DD} = 5V	4.95		4.95	5		4.95		V
		V _{DD} = 10V	9.95		9.95	10		9.95		V
		V _{DD} = 15V	14.95		14.95	15		14.95		V
V _{IL}	Low Level Input Voltage Comparator and Signal In	V _{DD} = 5V, V _O = 0.5V or 4.5V		1.5		2.25	1.5		1.5	V
		V _{DD} = 10V, V _O = 1V or 9V		3.0		4.5	3.0		3.0	V
		V _{DD} = 15V, V _O = 1.5V or 13.5V		4.0		6.25	4.0		4.0	V
V _{IH}	High Level Input Voltage Comparator and Signal In	V _{DD} = 5V, V _O = 0.5V or 4.5V	3.5		3.5	2.75		3.5		V
		V _{DD} = 10V, V _O = 1V or 9V	7.0		7.0	5.5		7.0		V
		V _{DD} = 15V, V _O = 1.5V or 13.5V	11.0		11.0	8.25		11.0		V
I _{OL}	Low Level Output Current (Note 4)	V _{DD} = 5V, V _O = 0.4V	0.52		0.44	0.88		0.36		mA
		V _{DD} = 10V, V _O = 0.5V	1.3		1.1	2.25		0.9		mA
		V _{DD} = 15V, V _O = 1.5V	3.6		3.0	8.8		2.4		mA
I _{OH}	High Level Output Current (Note 4)	V _{DD} = 5V, V _O = 4.6V	-0.52		-0.44	-0.88		-0.36		mA
		V _{DD} = 10V, V _O = 9.5V	-1.3		-1.1	-2.25		-0.9		mA
		V _{DD} = 15V, V _O = 13.5V	-3.6		-3.0	-8.8		-2.4		mA
I _{IN}	Input Current	All Inputs Except Signal Input V _{DD} = 15V, V _{IN} = 0V		-0.3		-10 ⁻⁵	-0.3		-1.0	μA
		V _{DD} = 15V, V _{IN} = 15V		0.3		10 ⁻⁵	0.3		1.0	μA
C _{IN}	Input Capacitance	Any Input (Note 3)					7.5			pF
P _T	Total Power Dissipation	f _o = 10 kHz, R1 = 1 MΩ, R2 = ∞, VCO _{IN} = V _{DD} /2								
		V _{DD} = 5V				0.07				mW
		V _{DD} = 10V				0.6				mW
		V _{DD} = 15V				2.4				mW

Note 1: "Absolute Maximum Ratings" are those values beyond which the safety of the device cannot be guaranteed. They are not meant to imply that the devices should be operated at these limits. The table of "Recommended Operating Conditions" and "Electrical Characteristics" provides conditions for actual device operation.

Note 2: V_{SS} = 0V unless otherwise specified.

Note 3: Capacitance is guaranteed by periodic testing.

Note 4: I_{OH} and I_{OL} are tested one output at a time.

AC Electrical Characteristics* CD4046BM/CD4046BC $T_A = 25^\circ\text{C}$, $C_L = 50\text{ pF}$

Symbol	Parameter	Conditions	Min	Typ	Max	Units
VCO SECTION						
I_{DD}	Operating Current	$f_o = 10\text{ kHz}$, $R1 = 1\text{ M}\Omega$, $R2 = \infty$, $V_{COIN} = V_{DD}/2$ $V_{DD} = 5\text{V}$ $V_{DD} = 10\text{V}$ $V_{DD} = 15\text{V}$		20 90 200		μA μA μA
f_{MAX}	Maximum Operating Frequency	$C1 = 50\text{ pF}$, $R1 = 10\text{ k}\Omega$, $R2 = \infty$, $V_{COIN} = V_{DD}$ $V_{DD} = 5\text{V}$ $V_{DD} = 10\text{V}$ $V_{DD} = 15\text{V}$	0.4 0.6 1.0	0.8 1.2 1.6		MHz MHz MHz
	Linearity	$V_{COIN} = 2.5\text{V} \pm 0.3\text{V}$, $R1 \geq 10\text{ k}\Omega$, $V_{DD} = 5\text{V}$		1		%
		$V_{COIN} = 5\text{V} \pm 2.5\text{V}$, $R1 \geq 400\text{ k}\Omega$, $V_{DD} = 10\text{V}$		1		%
		$V_{COIN} = 7.5\text{V} \pm 5\text{V}$, $R1 \geq 1\text{ M}\Omega$, $V_{DD} = 15\text{V}$		1		%
	Temperature-Frequency Stability No Frequency Offset, $f_{MIN} = 0$	$\% / ^\circ\text{C} \propto 1/f$, V_{DD} $R2 = \infty$ $V_{DD} = 5\text{V}$ $V_{DD} = 10\text{V}$ $V_{DD} = 15\text{V}$		0.12–0.24 0.04–0.08 0.015–0.03		$\% / ^\circ\text{C}$ $\% / ^\circ\text{C}$ $\% / ^\circ\text{C}$
Frequency Offset, $f_{MIN} \neq 0$	$V_{DD} = 5\text{V}$ $V_{DD} = 10\text{V}$ $V_{DD} = 15\text{V}$		0.06–0.12 0.05–0.1 0.03–0.06		$\% / ^\circ\text{C}$ $\% / ^\circ\text{C}$ $\% / ^\circ\text{C}$	
V_{COIN}	Input Resistance	$V_{DD} = 5\text{V}$		10^6		$\text{M}\Omega$
		$V_{DD} = 10\text{V}$		10^6		$\text{M}\Omega$
		$V_{DD} = 15\text{V}$		10^6		$\text{M}\Omega$
VCO	Output Duty Cycle	$V_{DD} = 5\text{V}$		50		%
		$V_{DD} = 10\text{V}$		50		%
		$V_{DD} = 15\text{V}$		50		%
t_{THL}	VCO Output Transition Time	$V_{DD} = 5\text{V}$		90	200	ns
t_{THL}		$V_{DD} = 10\text{V}$ $V_{DD} = 15\text{V}$		50 45	100 80	ns ns

*AC Parameters are guaranteed by DC correlated testing.

AC Electrical Characteristics* CD4046BM/CD4046BC $T_A = 25^\circ\text{C}$, $C_L = 50\text{ pF}$ (Continued)

Symbol	Parameter	Conditions	Min	Typ	Max	Units	
PHASE COMPARATORS SECTION							
R_{IN}	Input Resistance Signal Input	$V_{DD} = 5\text{V}$	1	3		$\text{M}\Omega$	
		$V_{DD} = 10\text{V}$	0.2	0.7		$\text{M}\Omega$	
		$V_{DD} = 15\text{V}$	0.1	0.3		$\text{M}\Omega$	
	Comparator Input	$V_{DD} = 5\text{V}$			10^6		$\text{M}\Omega$
		$V_{DD} = 10\text{V}$			10^6		$\text{M}\Omega$
		$V_{DD} = 15\text{V}$			10^6		$\text{M}\Omega$
AC-Coupled Signal Input Voltage Sensitivity	$C_{SERIES} = 1000\text{ pF}$ $f = 50\text{ kHz}$	$V_{DD} = 5\text{V}$		200	400	mV	
		$V_{DD} = 10\text{V}$		400	800	mV	
		$V_{DD} = 15\text{V}$		700	1400	mV	
DEMODULATOR OUTPUT							
V_{COIN-} V_{DEM}	Offset Voltage	$R_S \geq 10\text{ k}\Omega$, $V_{DD} = 5\text{V}$		1.50	2.2	V	
		$R_S \geq 10\text{ k}\Omega$, $V_{DD} = 10\text{V}$		1.50	2.2	V	
$R_S \geq 50\text{ k}\Omega$, $V_{DD} = 15\text{V}$			1.50	2.2	V		
	Linearity	$R_S \geq 50\text{ k}\Omega$					
		$V_{COIN} = 2.5\text{V} \pm 0.3\text{V}$, $V_{DD} = 5\text{V}$		0.1		%	
		$V_{COIN} = 5\text{V} \pm 2.5\text{V}$, $V_{DD} = 10\text{V}$		0.6		%	
		$V_{COIN} = 7.5\text{V} \pm 5\text{V}$, $V_{DD} = 15\text{V}$		0.8		%	
ZENER DIODE							
V_Z	Zener Diode Voltage	$I_Z = 50\text{ }\mu\text{A}$	6.3	7.0	7.7	V	
R_Z	Zener Dynamic Resistance	$I_Z = 1\text{ mA}$		100		Ω	

*AC Parameters are guaranteed by DC correlated testing.

Phase Comparator State Diagrams

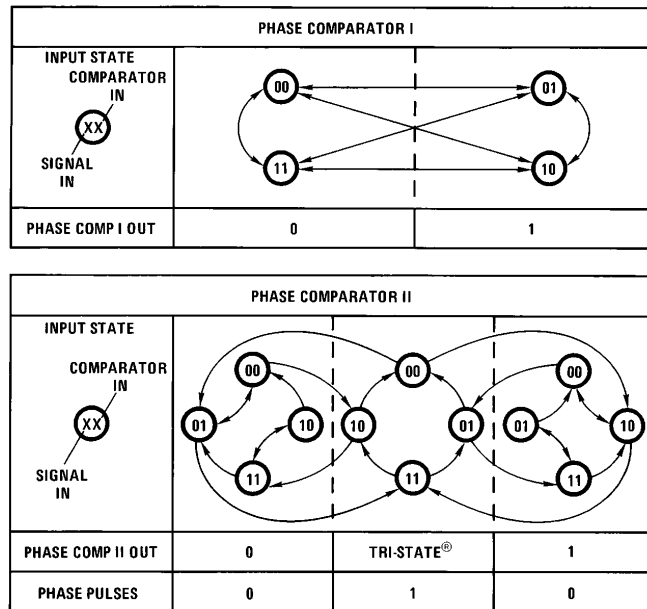

TL/F/5968-3

FIGURE 2

Typical Waveforms

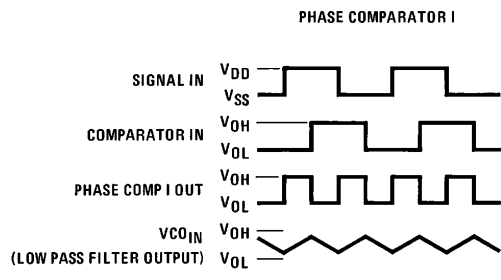

FIGURE 3. Typical Waveform Employing Phase Comparator I in Locked Condition

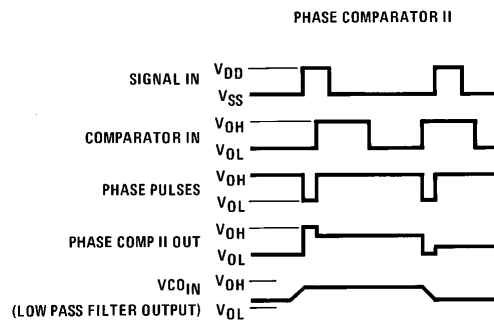
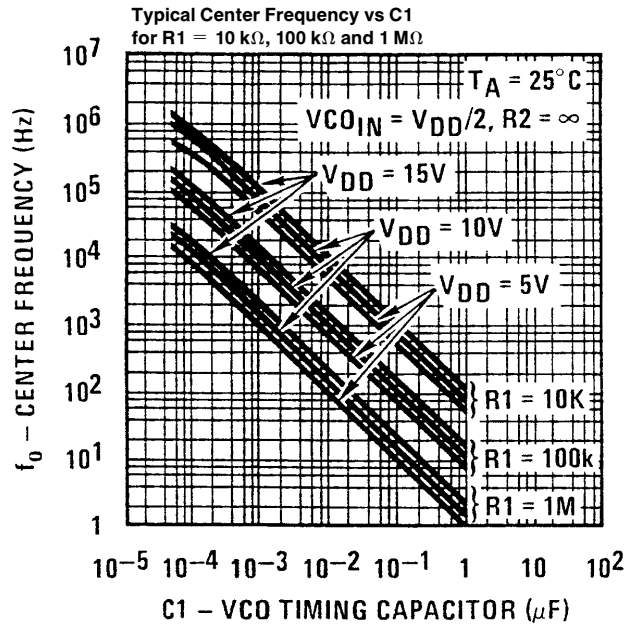

FIGURE 4. Typical Waveform Employing Phase Comparator II in Locked Condition

Typical Performance Characteristics



TL/F/5968-6

FIGURE 5a

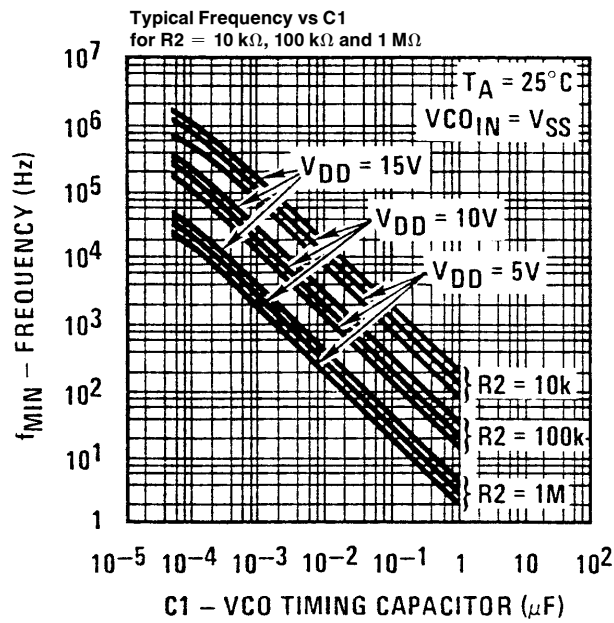

TL/F/5968-13

FIGURE 5b

Note: To obtain approximate total power dissipation of PLL system for no-signal input: Phase Comparator I, $P_D(\text{Total}) = P_D(f_0) + P_D(f_{MIN}) + P_D(R_S)$; Phase Comparator II, $P_D(\text{Total}) = P_D(f_{MIN})$.

Typical Performance Characteristics (Continued)

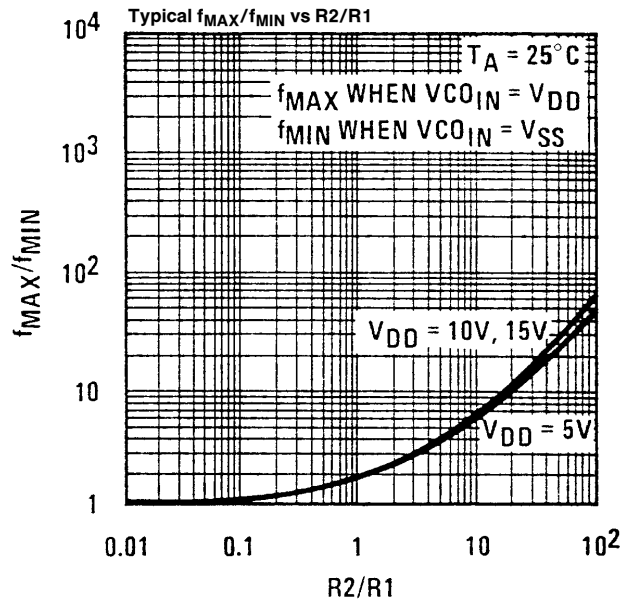

FIGURE 5C

TL/F/5968-14

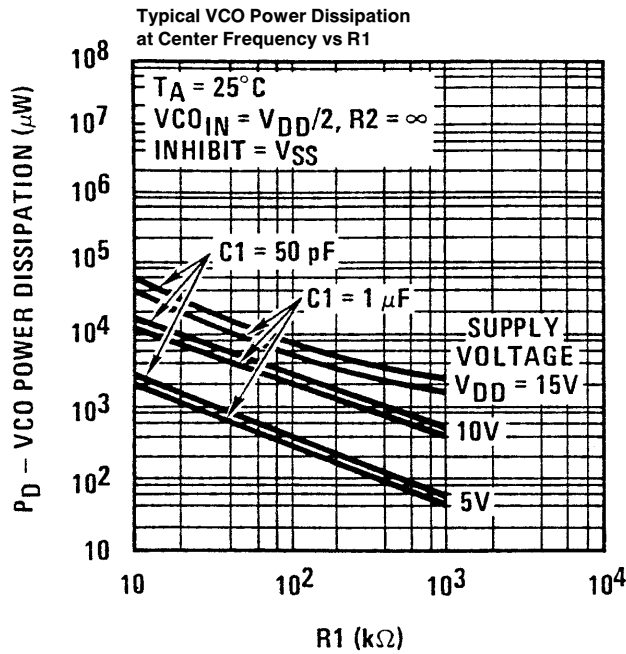

FIGURE 6a

TL/F/5968-15

Note: To obtain approximate total power dissipation of PLL system for no-signal input: Phase Comparator I, $P_D (Total) = P_D (f_o) + P_D (f_{MIN}) + P_D (R_S)$; Phase Comparator II, $P_D (Total) = P_D (f_{MIN})$.

Typical Performance Characteristics (Continued)

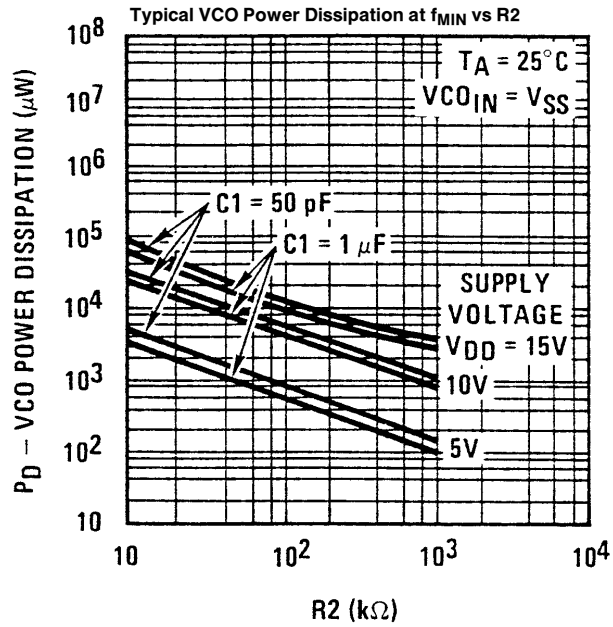

FIGURE 6b

TL/F/5968-16

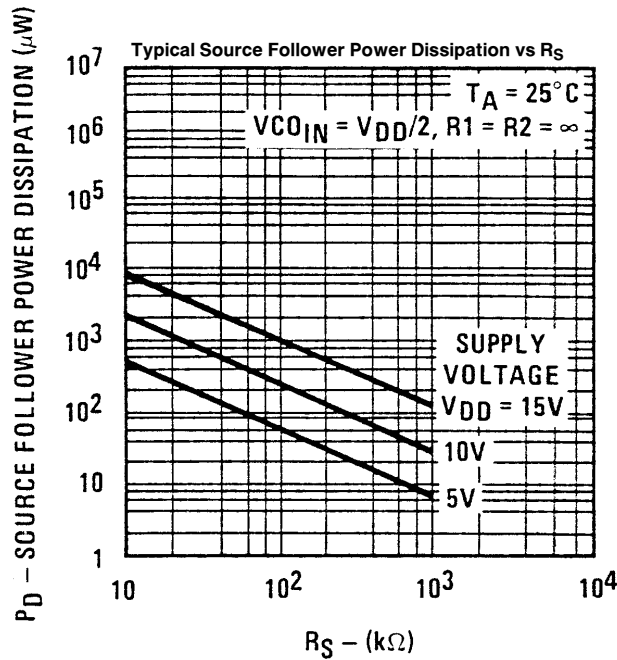
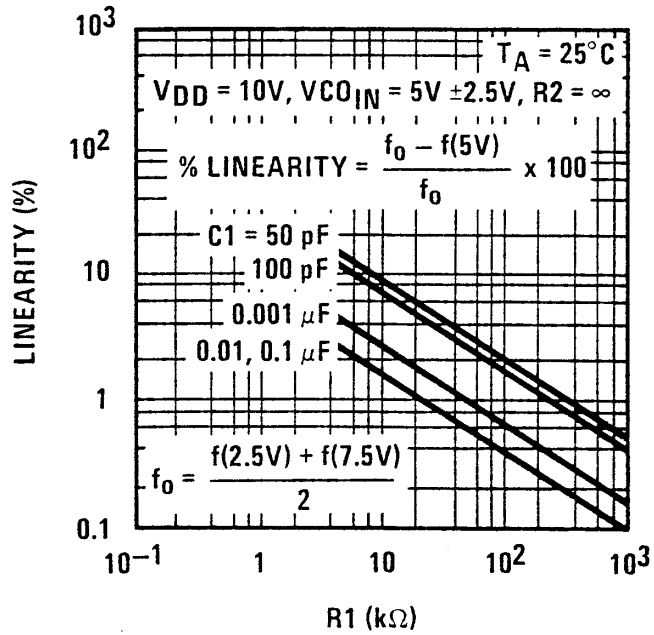

FIGURE 6c

TL/F/5968-17

Note: To obtain approximate total power dissipation of PLL system for no-signal input: Phase Comparator I, $P_D(\text{Total}) = P_D(f_0) + P_D(f_{MIN}) + P_D(R_S)$; Phase Comparator II, $P_D(\text{Total}) = P_D(f_{MIN})$.

Typical Performance Characteristics (Continued)



TL/F/5968-18

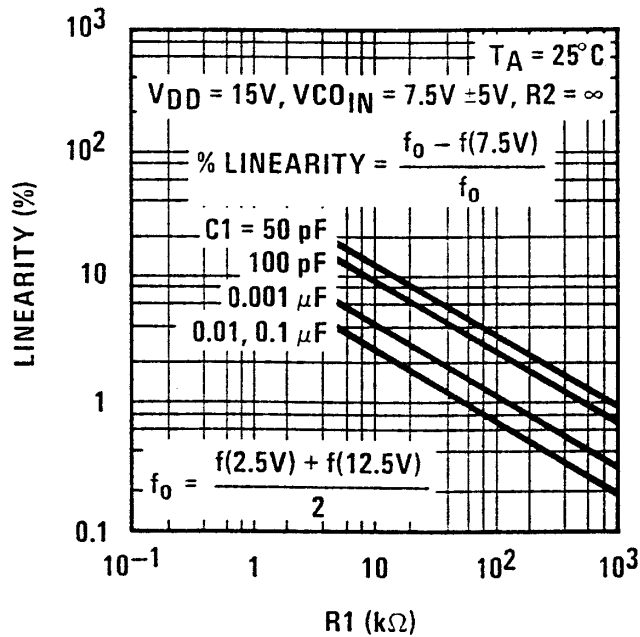

TL/F/5968-19

FIGURE 7. Typical VCO Linearity vs R1 and C1

Note: To obtain approximate total power dissipation of PLL system for no-signal input: Phase Comparator I, $P_D(\text{Total}) = P_D(f_0) + P_D(f_{\text{MIN}}) + P_D(R_S)$; Phase Comparator II, $P_D(\text{Total}) = P_D(f_{\text{MIN}})$.

Design Information

This information is a guide for approximating the value of external components for the CD4046B in a phase-locked-loop system. The selected external components must be within the following ranges: $R1, R2 \geq 10 \text{ k}\Omega$, $R_S \geq 10 \text{ k}\Omega$, $C1 \geq 50 \text{ pF}$.

In addition to the given design information, refer to *Figure 5* for $R1, R2$ and $C1$ component selections.

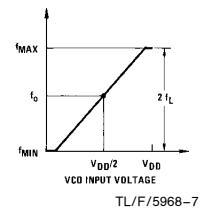
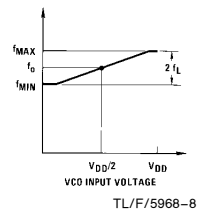
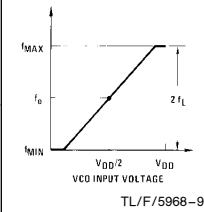
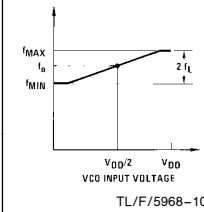
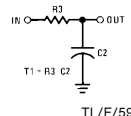
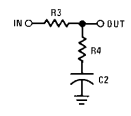
Characteristics	Using Phase Comparator I		Using Phase Comparator II	
	VCO Without Offset $R2 = \infty$	VCO With Offset	VCO Without Offset $R2 = \infty$	VCO With Offset
VCO Frequency	 TL/F/5968-7	 TL/F/5968-8	 TL/F/5968-9	 TL/F/5968-10
For No Signal Input	VCO in PLL system will adjust to center frequency, f_0		VCO in PLL system will adjust to lowest operating frequency, f_{min}	
Frequency Lock Range, $2 f_L$	$2 f_L = \text{full VCO frequency range}$ $2 f_L = f_{max} - f_{min}$			
Frequency Capture Range, $2 f_C$	 TL/F/5968-11 $2 f_C \approx \frac{1}{\pi} \sqrt{\frac{2 \pi f_L}{\tau 1}}$		$f_C = f_L$	
Loop Filter Component Selection	 TL/F/5968-12 For $2 f_C$, see Ref.			
Phase Angle Between Single and Comparator	90° at center frequency (f_0), approximating 0° and 180° at ends of lock range ($2 f_L$)		Always 0° in lock	
Locks on Harmonics of Center Frequency	Yes		No	
Signal Input Noise Rejection	High		Low	
VCO Component Selection	Given: f_0 . Use f_0 with <i>Figure 5a</i> to determine $R1$ and $C1$.	Given: f_0 and f_L . Calculate f_{min} from the equation $f_{min} = f_0 - f_L$. Use f_{min} with <i>Figure 5b</i> to determine $R2$ and $C1$. Calculate $\frac{f_{max}}{f_{min}}$ from the equation $\frac{f_{max}}{f_{min}} = \frac{f_0 + f_L}{f_0 - f_L}$. Use $\frac{f_{max}}{f_{min}}$ with <i>Figure 5c</i> to determine ratio $R2/R1$ to obtain $R1$.	Given: f_{max} . Calculate f_0 from the equation $f_0 = \frac{f_{max}}{2}$. Use f_0 with <i>Figure 5a</i> to determine $R1$ and $C1$.	Given: f_{min} and f_{max} . Use f_{min} with <i>Figure 5b</i> to determine $R2$ and $C1$. Calculate $\frac{f_{max}}{f_{min}}$. Use $\frac{f_{max}}{f_{min}}$ with <i>Figure 5c</i> to determine ratio $R2/R1$ to obtain $R1$.

References

- G.S. Moschytz, "Miniaturized RC Filters Using Phase-Locked Loop", BSTJ, May, 1965.
Floyd Gardner, "Phaselock Techniques", John Wiley & Sons, 1966.

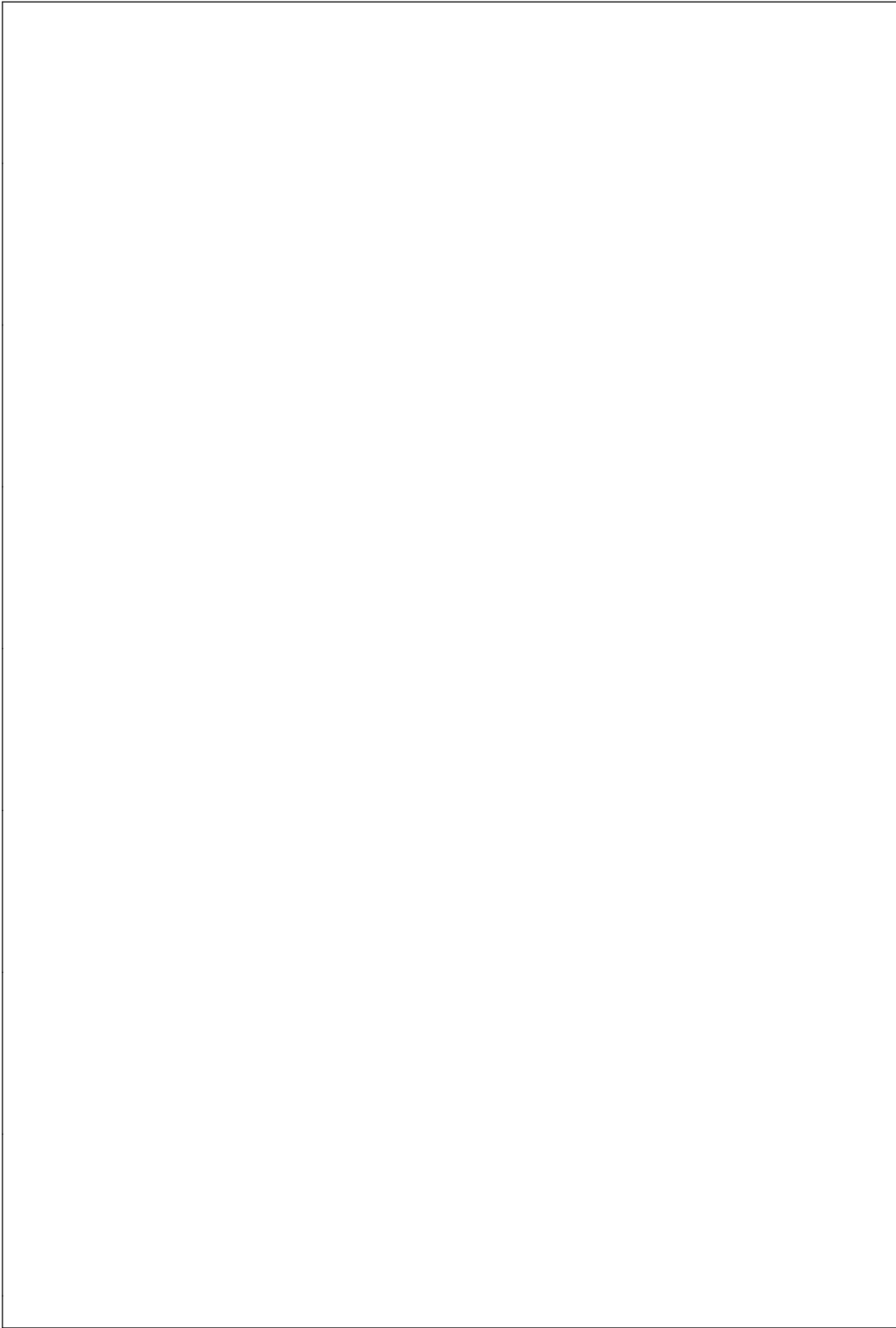

Physical Dimensions inches (millimeters)



Order Number CD4046BMJ or CD4046BCJ
NS Package Number J16A

J16A (REV L)

Physical Dimensions inches (millimeters) (Continued)

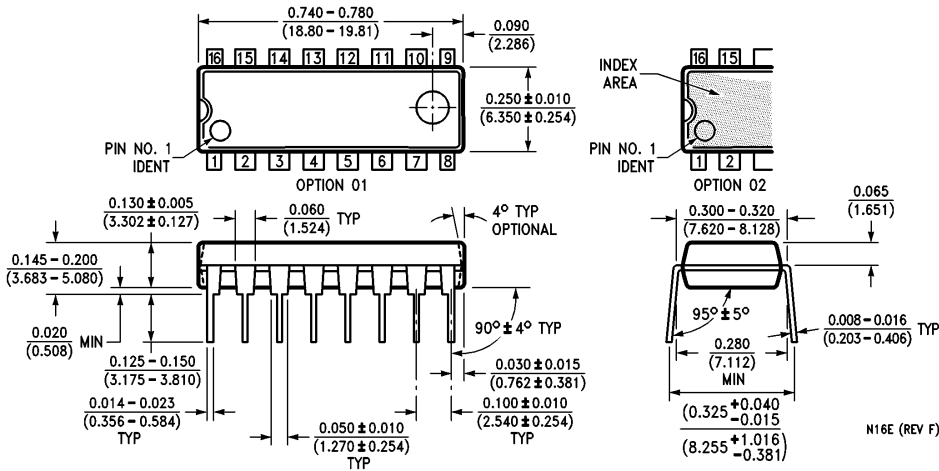

**Order Number CD4046BMN or CD4046BCN
NS Package Number N16E**

LIFE SUPPORT POLICY

NATIONAL'S PRODUCTS ARE NOT AUTHORIZED FOR USE AS CRITICAL COMPONENTS IN LIFE SUPPORT DEVICES OR SYSTEMS WITHOUT THE EXPRESS WRITTEN APPROVAL OF THE PRESIDENT OF NATIONAL SEMICONDUCTOR CORPORATION. As used herein:

1. Life support devices or systems are devices or systems which, (a) are intended for surgical implant into the body, or (b) support or sustain life, and whose failure to perform, when properly used in accordance with instructions for use provided in the labeling, can be reasonably expected to result in a significant injury to the user.
2. A critical component is any component of a life support device or system whose failure to perform can be reasonably expected to cause the failure of the life support device or system, or to affect its safety or effectiveness.



National Semiconductor Corporation
1111 West Bardin Road
Arlington, TX 76017
Tel: 1(800) 272-9959
Fax: 1(800) 737-7018

National Semiconductor Europe
Fax: (+49) 0-180-530 85 86
Email: cnjwge@tevm2.nsc.com
Deutsch Tel: (+49) 0-180-530 85 85
English Tel: (+49) 0-180-532 78 32
Français Tel: (+49) 0-180-532 93 58
Italiano Tel: (+49) 0-180-534 16 80

National Semiconductor Hong Kong Ltd.
19th Floor, Straight Block,
Ocean Centre, 5 Canton Rd.
Tsimshatsui, Kowloon
Hong Kong
Tel: (852) 2737-1600
Fax: (852) 2736-9960

National Semiconductor Japan Ltd.
Tel: 81-043-299-2309
Fax: 81-043-299-2408

National does not assume any responsibility for use of any circuitry described, no circuit patent licenses are implied and National reserves the right at any time without notice to change said circuitry and specifications.

This datasheet has been download from:

www.datasheetcatalog.com

Datasheets for electronics components.

National Semiconductor was acquired by Texas Instruments.

http://www.ti.com/corp/docs/investor_relations/pr_09_23_2011_national_semiconductor.html

This file is the datasheet for the following electronic components:

CD4046BM - <http://www.ti.com/product/cd4046bm?HQS=TI-null-null-dscatalog-df-pf-null-ww>

CD4046BC - <http://www.ti.com/product/cd4046bc?HQS=TI-null-null-dscatalog-df-pf-null-ww>