

DM74LS221 Dual Non-Retriggerable One-Shot with Clear and Complementary Outputs

General Description

The DM74LS221 is a dual monostable multivibrator with Schmitt-trigger input. Each device has three inputs permitting the choice of either leading-edge or trailing-edge triggering. Pin (A) is an active-low trigger transition input and pin (B) is an active-high transition Schmitt-trigger input that allows jitter free triggering for inputs with transition rates as slow as 1 volt/second. This provides the input with excellent noise immunity. Additionally an internal latching circuit at the input stage also provides a high immunity to V_{CC} noise. The clear (CLR) input can terminate the output pulse at a predetermined time independent of the timing components. This (CLR) input also serves as a trigger input when it is pulsed with a low level pulse transition (\neg). To obtain the best and trouble free operation from this device please read operating rules as well as the NSC one-shot application notes carefully and observe recommendations.

Features

- A dual, highly stable one-shot
- Compensated for V_{CC} and temperature variations

- Pin-out identical to 'LS123 (Note 1)
- Output pulse width range from 30 ns to 70 seconds
- Hysteresis provided at (B) input for added noise immunity
- Direct reset terminates output pulse
- Triggerable from CLEAR input
- DTL, TTL compatible
- Input clamp diodes

Note 1: The pin-out is identical to 'LS123 but, functionally it is not; refer to Operating Rules #10 in this datasheet.

Functional Description

The basic output pulse width is determined by selection of an external resistor (R_X) and capacitor (C_X). Once triggered, the basic pulse width is independent of further input transitions and is a function of the timing components, or it may be reduced or terminated by use of the active low CLEAR input. Stable output pulse width ranging from 30 ns to 70 seconds is readily obtainable.

Connection Diagram

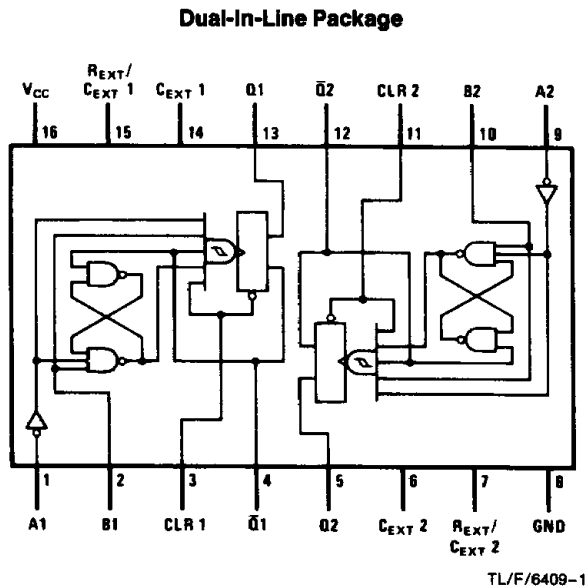

Order Number DM74LS221M or DM74LS221N
See NS Package Number M16A or N16A

Function Table

Inputs			Outputs	
CLEAR	A	B	Q	\bar{Q}
L	X	X	L	H
X	H	X	L	H
X	X	L	L	H
H	L	\uparrow	\neg	\neg
H	\downarrow	H	\neg	\neg
* \uparrow	L	H	\neg	\neg

- H = High Logic Level
- L = Low Logic Level
- X = Can Be Either Low or High
- \uparrow = Positive Going Transition
- \downarrow = Negative Going Transition
- \neg = A Positive Pulse
- \neg = A Negative Pulse

*This mode of triggering requires first the B input be set from a low to high level while the CLEAR input is maintained at logic low level. Then with the B input at logic high level, the CLEAR input whose positive transition from low to high will trigger an output pulse.

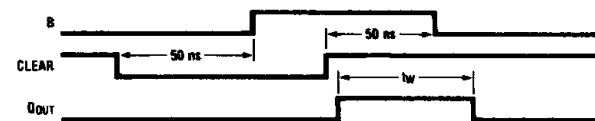

TL/F/6409-2

Absolute Maximum Ratings (Note)

If Military/Aerospace specified devices are required, please contact the National Semiconductor Sales Office/Distributors for availability and specifications.

Supply Voltage	7V
Input Voltage	7V
Operating Free Air Temperature Range	0°C to +70°C
DM74LS	
Storage Temperature Range	-65°C to +150°C

Note: The "Absolute Maximum Ratings" are those values beyond which the safety of the device cannot be guaranteed. The device should not be operated at these limits. The parametric values defined in the "Electrical Characteristics" table are not guaranteed at the absolute maximum ratings. The "Recommended Operating Conditions" table will define the conditions for actual device operation.

Recommended Operating Conditions

Symbol	Parameter		DM74LS221			Units
			Min	Nom	Max	
V _{CC}	Supply Voltage		4.75	5	5.25	V
V _{T+}	Positive-Going Input Threshold Voltage at the A Input (V _{CC} = Min)			1	2	V
V _{T-}	Negative-Going Input Threshold Voltage at the A Input (V _{CC} = Min)		0.8	1		V
V _{T+}	Positive-Going Input Threshold Voltage at the B Input (V _{CC} = Min)			1	2	V
V _{T-}	Negative-Going Input Threshold Voltage at the B Input (V _{CC} = Min)		0.8	0.9		V
I _{OH}	High Level Output Current				-0.4	mA
I _{OL}	Low Level Output Current				8	mA
t _w	Pulse Width (Note 1)	Data	40			ns
		Clear	40			ns
t _{REL}	Clear Release Time (Note 1)		15			ns
$\frac{dV}{dt}$	Rate of Rise or Fall of Schmitt Input (B) (Note 1)				1	$\frac{V}{s}$
$\frac{dV}{dt}$	Rate of Rise or Fall of Logic Input (A) (Note 1)				1	$\frac{V}{\mu s}$
R _{EXT}	External Timing Resistor (Note 1)		1.4		100	kΩ
C _{EXT}	External Timing Capacitance (Note 1)		0		1000	μF
DC	Duty Cycle (Note 1)	R _T = 2 kΩ			50	%
		R _T = R _{EXT} (Max)			60	
T _A	Free Air Operating Temperature		0		70	°C

Note 1: T_A = 25°C and V_{CC} = 5V.

Electrical Characteristics over recommended operating free air temperature range (unless otherwise noted)

Symbol	Parameter	Conditions	Min	Typ (Note 1)	Max	Units
V _I	Input Clamp Voltage	V _{CC} = Min, I _I = -18 mA			-1.5	V
V _{OH}	High Level Output Voltage	V _{CC} = Min, I _{OH} = Max V _{IL} = Max, V _{IH} = Min	2.7	3.4		V
V _{OL}	Low Level Output Voltage	V _{CC} = Min, I _{OL} = Max V _{IL} = Max, V _{IH} = Min		0.35	0.5	V
		V _{CC} = Min, I _{OL} = 4 mA			0.4	
I _I	Input Current @ Max Input Voltage	V _{CC} = Max, V _I = 7V			0.1	mA

Electrical Characteristics

over recommended operating free air temperature range (unless otherwise noted) (Continued)

Symbol	Parameter	Conditions	Min	Typ (Note 1)	Max	Units
I_{IH}	High Level Input Current	$V_{CC} = \text{Max}, V_I = 2.7V$			20	μA
I_{IL}	Low Level Input Current	$V_{CC} = \text{Max}$ $V_I = 0.4V$	A1, A2		-0.4	mA
			B		-0.8	
			Clear		-0.8	
I_{OS}	Short Circuit Output Current	$V_{CC} = \text{Max}$ (Note 2)	-20		-100	mA
I_{CC}	Supply Current	$V_{CC} = \text{Max}$	Quiescent	4.7	11	mA
			Triggered	19	27	

Note 1: All typicals are at $V_{CC} = 5V, T_A = 25^\circ C$.**Note 2:** Not more than one output should be shorted at a time, and the duration should not exceed one second.**Switching Characteristics** at $V_{CC} = 5V$ and $T_A = 25^\circ C$ (See Section 1 for Test Waveforms and Output Load)

Symbol	Parameter	From (Input) To (Output)	Conditions	Min	Max	Units	
t_{PLH}	Propagation Delay Time Low to High Level Output	A1, A2 to Q	$C_{EXT} = 80 \text{ pF}$ $R_{EXT} = 2 \text{ k}\Omega$ $C_L = 15 \text{ pF}$ $R_L = 2 \text{ k}\Omega$		70	ns	
t_{PLH}	Propagation Delay Time Low to High Level Output	B to Q				55	ns
t_{PHL}	Propagation Delay Time High to Low Level Output	A1, A2 to Q				80	ns
t_{PHL}	Propagation Delay Time High to Low Level Output	B to \bar{Q}				65	ns
t_{PLH}	Propagation Delay Time Low to High Level Output	Clear to \bar{Q}				65	ns
t_{PHL}	Propagation Delay Time High to Low Level Output	Clear to Q				55	ns
$t_{W(out)}$	Output Pulse Width Using Zero Timing Capacitance	A1, A2 to Q, \bar{Q}	$C_{EXT} = 0$ $R_{EXT} = 2 \text{ k}\Omega$ $R_L = 2 \text{ k}\Omega$ $C_L = 15 \text{ pF}$	20	70	ns	
$t_{W(out)}$	Output Pulse Width Using External Timing Resistor	A1, A2 to Q, \bar{Q}	$C_{EXT} = 100 \text{ pF}$ $R_{EXT} = 10 \text{ k}\Omega$ $R_L = 2 \text{ k}\Omega$ $C_L = 15 \text{ pF}$	600	750	ns	
			$C_{EXT} = 1 \mu F$ $R_{EXT} = 10 \text{ k}\Omega$ $R_L = 2 \text{ k}\Omega$ $C_L = 15 \text{ pF}$	6	7.5	ms	
			$C_{EXT} = 80 \text{ pF}$ $R_{EXT} = 2 \text{ k}\Omega$ $R_L = 2 \text{ k}\Omega$ $C_L = 15 \text{ pF}$	70	150	ns	

Operating Rules

1. An external resistor (R_X) and an external capacitor (C_X) are required for proper operation. The value of C_X may vary from 0 to approximately 1000 μF . For small time constants high-grade mica, glass, polypropylene, polycarbonate, or polystyrene material capacitor may be used. For large time constants use tantalum or special aluminum capacitors. If timing capacitor has leakages approaching 100 nA or if stray capacitance from either terminal to ground is greater than 50 pF the timing equations may not represent the pulse width the device generates.
2. When an electrolytic capacitor is used for C_X a switching diode is often required for standard TTL one-shots to prevent high inverse leakage current. This switching diode is not needed for the 'LS221 one-shot and should not be used.
3. For $C_X \gg 1000$ pF, the output pulse width (T_W) is defined as follows:

$$T_W = KR_X C_X$$
 where [R_X is in $k\Omega$]
 [C_X is in pF]
 [T_W is in ns]
 $K \approx \text{Ln}2 = 0.70$
4. The multiplicative factor K is plotted as a function of C_X below for design considerations:

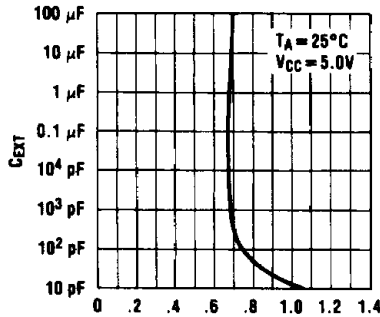

FIGURE 1

TL/F/6409-3

5. For $C_X < 1000$ pF see Figure 2 for T_W vs C_X family curves with R_X as a parameter:

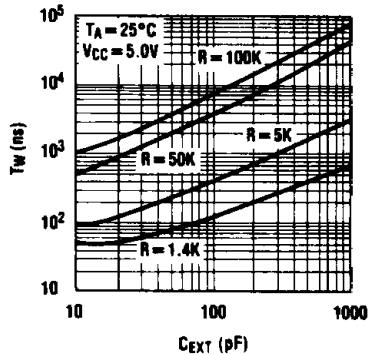
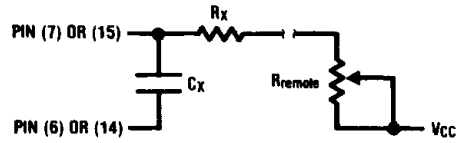

FIGURE 2

TL/F/6409-4

6. To obtain variable pulse widths by remote trimming, the following circuit is recommended:



TL/F/6409-5

Note: " R_{remote} " should be as close to the one-shot as possible.

FIGURE 3

7. Output pulse width versus V_{CC} and temperatures: Figure 4 depicts the relationship between pulse width variation versus V_{CC} . Figure 5 depicts pulse width variation versus temperatures.

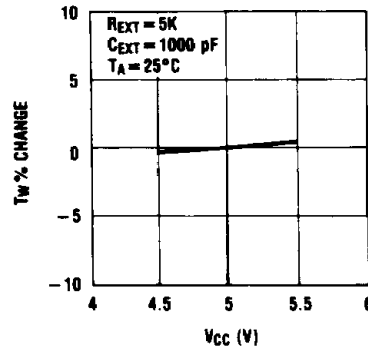

FIGURE 4

TL/F/6409-6

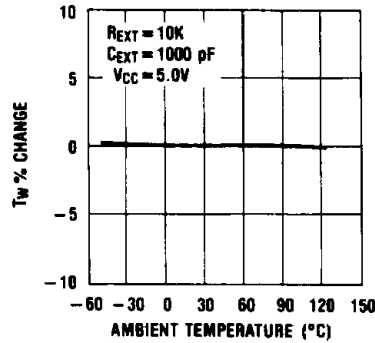

FIGURE 5

TL/F/6409-7

8. Duty cycle is defined as $T_W/T \times 100$ in percentage, if it goes above 50% the output pulse width will become shorter. If the duty cycle varies between low and high values, this causes output pulse width to vary, or jitter (a function of the R_{EXT} only). To reduce jitter, R_{EXT} should be as large as possible, for example, with $R_{\text{EXT}} = 100k$ jitter is not appreciable until the duty cycle approaches 90%.

Operating Rules (Continued)

9. Under any operating condition C_X and R_X must be kept as close to the one-shot device pins as possible to minimize stray capacitance, to reduce noise pick-up, and to reduce $I \cdot R$ and $L di/dt$ voltage developed along their connecting paths. If the lead length from C_X to pins (6) and (7) or pins (14) and (15) is greater than 3 cm, for example, the output pulse width might be quite different from values predicted from the appropriate equations. A non-inductive and low capacitive path is necessary to ensure complete discharge of C_X in each cycle of its operation so that the output pulse width will be accurate.
10. Although the 'LS221's pin-out is identical to the 'LS123 it should be remembered that they are not functionally identical. The 'LS123 is a retriggerable device such that the output is dependent upon the input transitions when

its output "Q" is at the "High" state. Furthermore, it is recommended for the 'LS123 to externally ground the C_{EXT} pin for improved system performance. However, this pin on the 'LS221 is not an internal connection to the device ground. Hence, if substitution of an 'LS221 onto an 'LS123 design layout where the C_{EXT} pin is wired to the ground, the device will not function.

11. V_{CC} and ground wiring should conform to good high-frequency standards and practices so that switching transients on the V_{CC} and ground return leads do not cause interaction between one-shots. A 0.01 μF to 0.10 μF bypass capacitor (disk ceramic or monolithic type) from V_{CC} to ground is necessary on each device. Furthermore, the bypass capacitor should be located as close to the V_{CC} -pin as space permits.

For further detailed device characteristics and output performance, please refer to the NSC one-shot application note AN-366.

This datasheet has been downloaded from:

www.DatasheetCatalog.com

Datasheets for electronic components.

National Semiconductor was acquired by Texas Instruments.

http://www.ti.com/corp/docs/investor_relations/pr_09_23_2011_national_semiconductor.html

This file is the datasheet for the following electronic components:

DM74LS221N - <http://www.ti.com/product/dm74ls221n?HQS=TI-null-null-dscatalog-df-pf-null-wwe>

DM74LS221M - <http://www.ti.com/product/dm74ls221m?HQS=TI-null-null-dscatalog-df-pf-null-wwe>