

## 1.5A, 50V - 1000V Standard Rectifier

### FEATURES

- AEC-Q101 qualified available
- Glass passivated chip junction
- High efficiency, Low  $V_F$
- High current capability
- High surge current capability
- Low power loss
- RoHS Compliant
- Halogen-free

### APPLICATIONS

- DC to DC converter
- Switching mode converters and inverters
- General purpose

### MECHANICAL DATA

- Case: DO-204AC (DO-15)
- Molding compound meets UL 94V-0 flammability rating
- Terminal: Pure tin plated leads, solderable per J-STD-002
- Meet JESD 201 class 2 whisker test
- Polarity: Indicated by cathode band
- Weight: 0.400g (approximately)

KEY PARAMETERS		
PARAMETER	VALUE	UNIT
$I_F$	1.5	A
$V_{RRM}$	50 - 1000	V
$I_{FSM}$	50	A
$T_{JMAX}$	150	°C
Package	DO-204AC (DO-15)	
Configuration	Single die	



DO-204AC (DO-15)



ABSOLUTE MAXIMUM RATINGS ( $T_A = 25^\circ\text{C}$ unless otherwise noted)									
PARAMETER	SYMBOL	1N 5391G	1N 5392G	1N 5393G	1N 5395G	1N 5397G	1N 5398G	1N 5399G	UNIT
Marking code on the device		1N 5391G	1N 5392G	1N 5393G	1N 5395G	1N 5397G	1N 5398G	1N 5399G	
Repetitive peak reverse voltage	$V_{RRM}$	50	100	200	400	600	800	1000	V
Reverse voltage, total rms value	$V_{R(RMS)}$	35	70	140	280	420	560	700	V
Forward current	$I_F$	1.5							A
Surge peak forward current, 8.3ms single half sine wave superimposed on rated load	$I_{FSM}$	50							A
Junction temperature	$T_J$	-55 to +150							°C
Storage temperature	$T_{STG}$	-55 to +150							°C

<b>THERMAL PERFORMANCE</b>			
<b>PARAMETER</b>	<b>SYMBOL</b>	<b>TYP</b>	<b>UNIT</b>
Junction-to-ambient thermal resistance	$R_{\theta JA}$	65	°C/W

<b>ELECTRICAL SPECIFICATIONS</b> ( $T_A = 25^\circ\text{C}$ unless otherwise noted)						
<b>PARAMETER</b>		<b>CONDITIONS</b>	<b>SYMBOL</b>	<b>TYP</b>	<b>MAX</b>	<b>UNIT</b>
Forward voltage <sup>(1)</sup>	1N5391G 1N5392G	$I_F = 1.5\text{A}, T_J = 25^\circ\text{C}$	$V_F$	-	1.1	V
	1N5393G 1N5395G 1N5397G 1N5398G 1N5399G			-	1.0	V
Reverse current @ rated $V_R$ <sup>(2)</sup>		$T_J = 25^\circ\text{C}$	$I_R$	-	5	$\mu\text{A}$
		$T_J = 125^\circ\text{C}$		-	100	$\mu\text{A}$
Junction capacitance		1MHz, $V_R = 4.0\text{V}$	$C_J$	15	-	pF

**Notes:**

1. Pulse test with  $PW = 0.3\text{ms}$
2. Pulse test with  $PW = 30\text{ms}$

<b>ORDERING INFORMATION</b>		
<b>ORDERING CODE</b> <sup>(1)(2)</sup>	<b>PACKAGE</b>	<b>PACKING</b>
1N539xG	DO-204AC (DO-15)	3,500 / Tape & Reel
1N539xG A0G	DO-204AC (DO-15)	1,500 / Ammo box
1N539xGH	DO-204AC (DO-15)	3,500 / Tape & Reel
1N539xGHA0G	DO-204AC (DO-15)	1,500 / Ammo box

**Notes:**

1. "x" defines voltage from 50V (1N5391G) to 1000V (1N5399G)
2. "H" means AEC-Q101 qualified

**CHARACTERISTICS CURVES**

( $T_A = 25^\circ\text{C}$  unless otherwise noted)

**Fig.1 Forward Current Derating Curve**

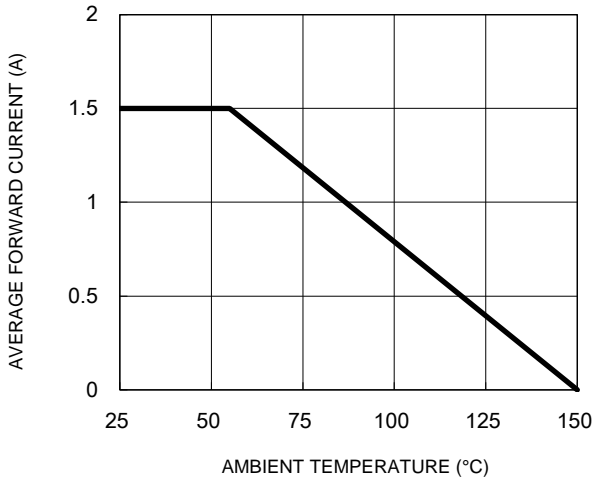

**Fig.2 Typical Junction Capacitance**

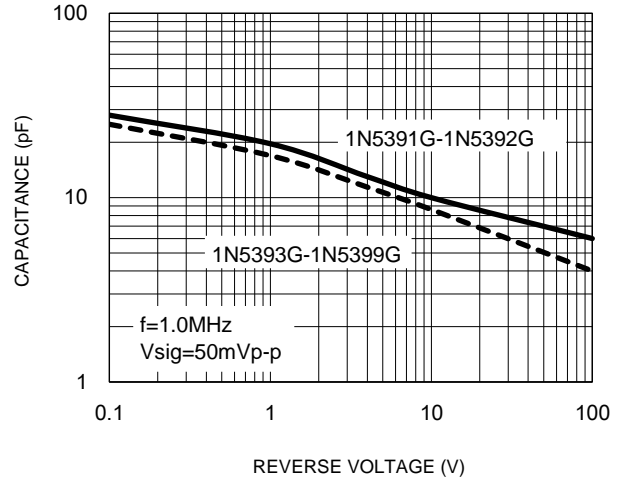

**Fig.3 Typical Reverse Characteristics**

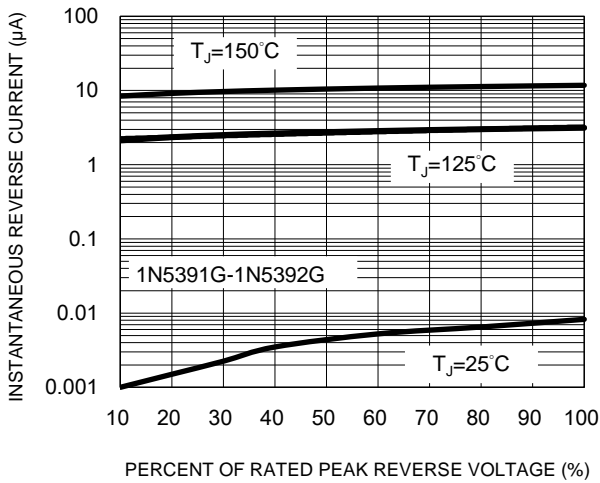

**Fig.5 Typical Reverse Characteristics**

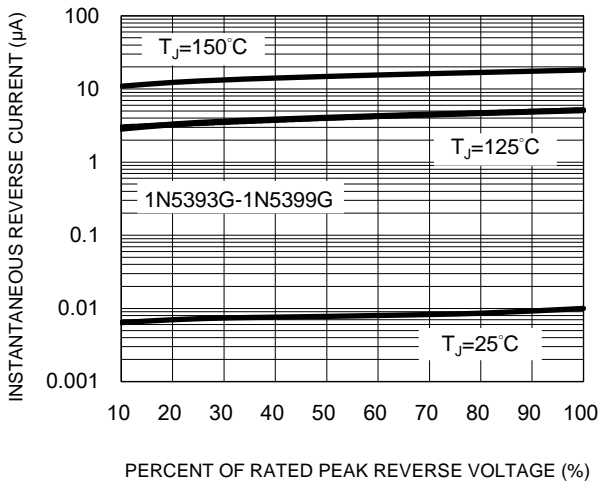

**Fig.4 Typical Forward Characteristics**

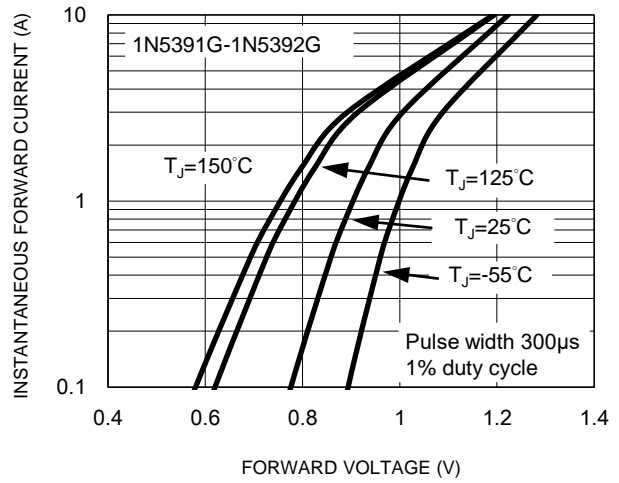

**Fig.6 Typical Forward Characteristics**

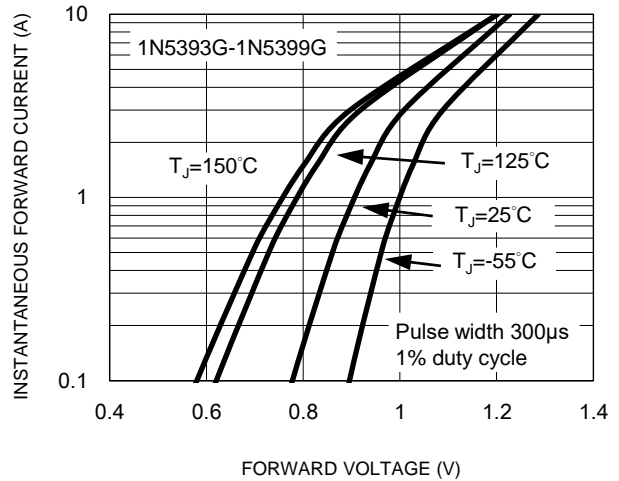

**CHARACTERISTICS CURVES**

(T<sub>A</sub> = 25°C unless otherwise noted)

**Fig.7 Maximum Non-Repetitive Forward Surge Current**

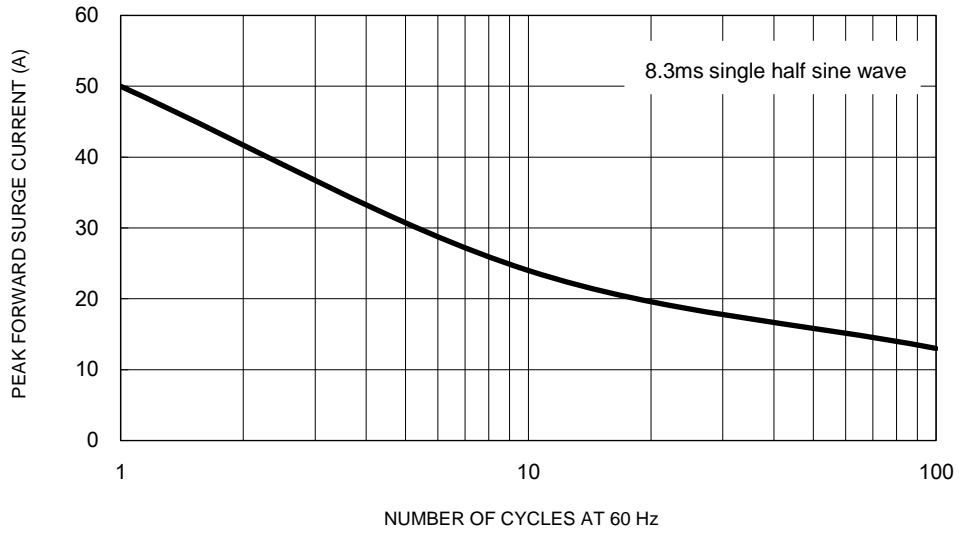

**PACKAGE OUTLINE DIMENSIONS**

DO-204AC (DO-15)

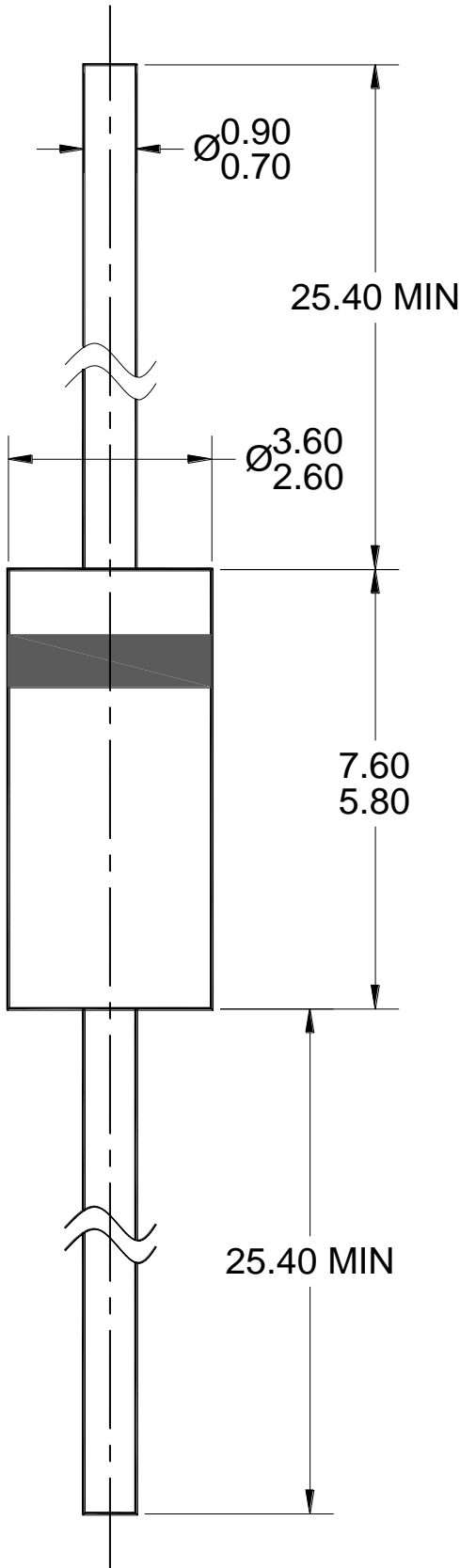

NOTES: UNLESS OTHERWISE SPECIFIED

1. ALL DIMENSIONS ARE IN MILLIMETERS.
2. DIMENSIONING AND TOLERANCING PER ASME Y14.5M-1994.
3. DWG NO. REF: HQ2SD07-DO15-078 REV A.

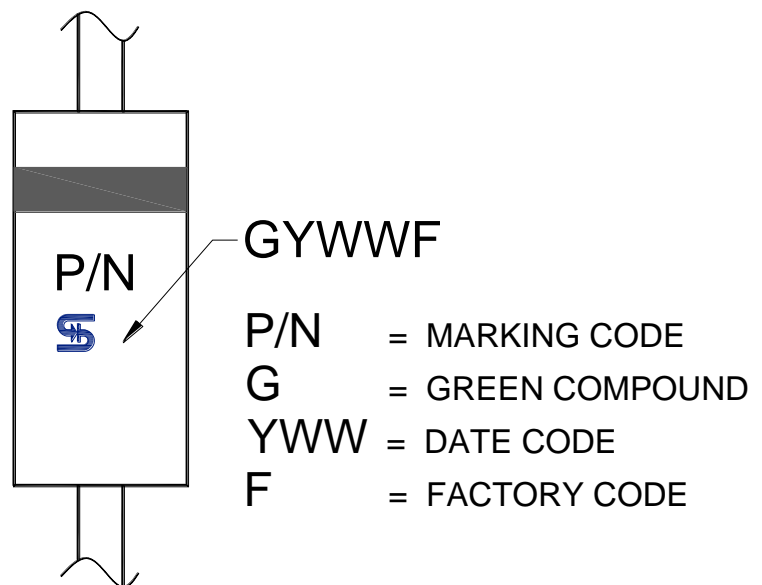

MARKING DIAGRAM

## **Notice**

Specifications of the products displayed herein are subject to change without notice. TSC or anyone on its behalf, assumes no responsibility or liability for any errors or inaccuracies.

Purchasers are solely responsible for the choice, selection, and use of TSC products and TSC assumes no liability for application assistance or the design of Purchasers' products.

Information contained herein is intended to provide a product description only. No license, express or implied, to any intellectual property rights is granted by this document. Except as provided in TSC's terms and conditions of sale for such products, TSC assumes no liability whatsoever, and disclaims any express or implied warranty, relating to sale and/or use of TSC products including liability or warranties relating to fitness for a particular purpose, merchantability, or infringement of any patent, copyright, or other intellectual property right.

The products shown herein are not designed for use in medical, life-saving, or life-sustaining applications. Customers using or selling these products for use in such applications do so at their own risk and agree to fully indemnify TSC for any damages resulting from such improper use or sale.